



rabalux[®] LiTrack





EN

Today, in all areas of life, we are looking for solutions that are adaptable, versatile and flexible. Our homes are no exception, with a growing preference for lighting options that offer both functionality and aesthetics. With modern interior design trends focusing on customisable, easily variable systems, track lighting systems have become particularly popular in homes. This lighting solution allows free placement and movement of light sources, making it a great way to adapt to our rhythm of life.

Rábalux's new product range - the LiTrack track lighting system - is perfectly adapted to these needs, using the latest technology: our slim, magnetic, 24V system offers several advantages:

- **Easy installation:** one-stop solution, simple and easy to install.
- **Safety:** low voltage design makes it completely safe, child friendly.
- **Complete system:** ideal for lighting a whole house or a single room.
- **Stylish look:** its slim, minimalist design makes it easy to blend into the space of your home, giving it a modern, tasteful look. The different lamp heads offer a variety of looks.
- **Flexible:** the system is easy to cut, vary and expand, making it a great fit for any space.
- **Energy- and cost-effective:** LED lamp heads are energy-efficient and long-lasting. Energy-efficient and energy efficient.

The Rábalux LiTrack track lighting system offers the additional benefit of the Click&Light function, which allows quick and easy lighting control. Choose Rábalux and enjoy flexibility, safety and style in one well-designed system!

HU

Manapság az élet minden területén azokat a megoldásokat keressük, amelyek életvitelünkhöz hangolhatók, sokoldalúak és rugalmasak. Ez alól otthonunk sem kivétel, ahol egyre inkább olyan világítási lehetőségeket részesítünk előnyben, amelyek egyszerre kínálnak funkcionalitást és esztétikumot. A modern belsőépítészeti trendek a személyre szabható, könnyen variálható rendszereket helyezik előtérbe, ezért a sínes lámparendszerek különösen népszerűvé váltak az otthonokban. Ez a világítási megoldás lehetővé teszi a fényforrások szabad elhelyezését és mozgását, így remekül alkalmazkodik életritmusunkhoz.

A Rábalux új termékcsaládja – a LiTrack sínes lámparendszer - tökéletesen illeszkedik ezekhez az igényekhez, mely a legújabb technológiával érhető el: vékony, mágneses, 24V-os rendszerünk számos előnyt kínál:

- **Könnyű telepítés:** egy kiállással megoldható, egyszerűen és könnyen telepíthető.
- **Biztonság:** kismegnyomású kialakítása révén teljesen biztonságos, gyerekbarát.
- **Komplett rendszer:** Ideális akár egy egész ház, akár egyetlen helyiség megvilágítására.
- **Stílusos megjelenés:** A vékony, minimalista dizájnja révén könnyen belesimul otthonunk tereibe, modern, ízléses megjelenés kölcsönözve azoknak. A különböző lámpafejek változatos megjelenést kínálnak.
- **Rugalmas:** A rendszer egyszerűen vágható, variálható és bővíthető, így remekül illeszthető bármilyen térhez.
- **Energia- és költséghatékony:** A LED lámpafejek energiahatékonyak, hosszú élettartamúak. Egyetlen elosztódoboz - driver használatával a sínes lámpák konfigurálhatók.

A Rábalux LiTrack sínes lámparendszerének további előnyei közé tartozik a Click&Light funkció, amely lehetővé teszi a gyors és egyszerű világításvezérlést. Válassza a Rábaluxot, és élvezze a rugalmasságot, a biztonságot és a stílust egyetlen, jól megtervezett rendszerben!

DE

In allen Bereichen des Lebens suchen wir heute nach Lösungen, die anpassungsfähig, vielseitig und flexibel sind. Unser Zuhause bildet da keine Ausnahme, denn wir bevorzugen zunehmend Beleuchtungsoptionen, die sowohl Funktionalität als auch Ästhetik bieten. Da sich die modernen Trends in der Innenarchitektur auf individuell anpassbare, leicht zu verändernden Systemen konzentrieren, sind Strahlschienebeleuchtungssysteme in Wohnungen und Büros besonders beliebt geworden. Diese Beleuchtungslösung ermöglicht die freie Platzierung und Bewegung von Lichtquellen und ist damit eine gute Möglichkeit, sich unserem Lebensrhythmus anzupassen.

Die neue Produktpalette von Rábalux - das LiTrack-Schienebeleuchtungssystem - ist perfekt auf diese Bedürfnisse abgestimmt und nutzt die neueste Technologie: Unser schlankes, magnetisches 24-Volt-System bietet eine Reihe von Vorteilen:

- **Einfache Installation:** Eine Lösung aus einer Hand, einfach und leicht zu installieren.
- **Sicherheit:** Niederspannung macht es absolut sicher, kinderfreundlich.
- **Komplettsystem:** ideal für die Beleuchtung eines ganzen Hauses oder eines einzelnen Zimmers.
- **Elegantes Aussehen:** Durch ihr schlankes, minimalistisches Design fügt sie sich leicht in den Raum Ihres Hauses ein und verleiht ihm ein modernes, geschmackvolles Aussehen. Die verschiedenen Leuchtenköpfe bieten eine Vielzahl von Gestaltungsmöglichkeiten.
- **Flexibel:** Das System lässt sich leicht zuschneiden, variieren und erweitern, so dass es für jeden Raum geeignet ist.
- **Energie- und kosteneffizient:** LED-Lampenköpfe sind energieeffizient und langlebig. Energie- und kosteneffizient.

Das Rábalux LiTrack-Schienebeleuchtungssystem bietet den zusätzlichen Vorteil der Click&Light-Funktion, die eine schnelle und einfache Lichtsteuerung ermöglicht. Entscheiden Sie sich für Rábalux und genießen Sie Flexibilität, Sicherheit und Stil in einem gut durchdachten System!

EN

WHAT IS A TRACK LIGHTING SYSTEM?

A track lighting system is a lighting solution in which luminaires are mounted on a track and can be moved freely on this track. The integrated LED lamp heads are variable and available in different types. The system is powered by an external power supply ("driver"). There are two types of drivers: a built-on driver, which can be mounted on the rail, and a built-in driver, which can be concealed, for example in a false ceiling. The system also includes connecting elements to create different shapes, limited only by your imagination.

Track systems are flexible and versatile, making them ideal for lighting any space, whether home, office or retail.

HU

MI AZ A SÍNES LÁMPARENDSZER?

A sínes lámparendszer egy olyan világítási megoldás, amelyben a lámpatestek egy sínre vannak felszerelve, és ezen a sínen szabadon mozgathatók. A beépített LED-es lámpafejek variálhatóak és különböző típusokban érhetőek el. A rendszert egy külső tápegység („driver”) működteti/látja el árammal. A tápegységből kétféle létezik: egyik a ráépíthető, amelyet a sínrre tudunk szerelni a másik a beépíthető, rejtett, melyet például álmennyezetbe szerelhetünk. A rendszer továbbá tartalmaz még összekötő elemeket, amivel különböző formákat hozhatunk létre, melynek csak a képzeletünk szabhat határt.

A sínes rendszerek rugalmasak és sokoldalúak, így ideálisak bármilyen tér megvilágítására, legyen az otthon, iroda vagy üzlethelyiség.

DE

WAS IST EIN STROMSCHIENEN-LICHTSYSTEM?

Ein Stromschienensystem ist eine Beleuchtungslösung, bei der die Leuchten an einer Schiene montiert sind und sich frei auf dieser Schiene bewegen können. Die integrierten LED-Lampenköpfe sind variabel und in verschiedenen Ausführungen erhältlich. Die Stromversorgung des Systems erfolgt über ein externes Netzteil („Driver“). Es gibt zwei Arten von Driver: eine Aufbaustromversorgung, die an der Schiene montiert werden kann, und eine Einbaustromversorgung, die z. B. in einer Zwischendecke verborgen werden kann. Das System umfasst auch Verbindungselemente, mit denen verschiedene Formen geschaffen werden können, die nur durch Ihre Fantasie begrenzt sind.

Stromschienensysteme sind flexibel und vielseitig und eignen sich daher ideal für die Beleuchtung jedes Raums, ob zu Hause, im Büro oder im Einzelhandel.



SYSTEM • RENDSZER • SYSTEM

1. RAIL SÍN SCHIENE



+

2. CONNECTING ELEMENTS AND END CAP ÖSSZEKÖTŐ ELEMENK ÉS VÉGZÁRÓ VERBINDUNGSELEMENTE UND ENDKAPPE

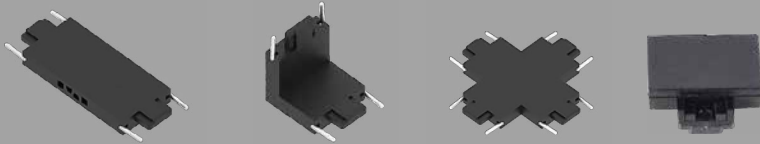

+

3. DRIVER MEGHAJTÓ TREIBER

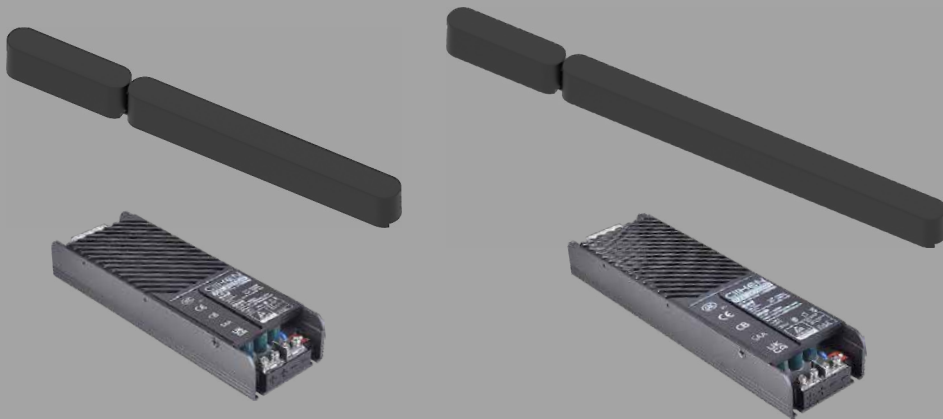

+

4. LAMP HEADS LÁMPAFEJEK LAMPENKÖPFE



SYSTEM ELEMENTS • RENDSZERELEMÉK • SYSTEMELEMENTE



RAIL
70199
9



RAIL
70200
9



RAIL
70201
9

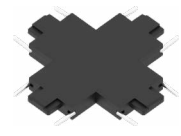

RAIL
70202
9



RAIL
70203
9



DRIVER
70204
11



DRIVER
70205
11



DRIVER
70208
11



DRIVER
70206
11



DRIVER
70207
11



LINE
70100
15



LINE
70101
15



LINE
70102
15



LINE
70111
15



LINE
70112
15



LINE
70113
15



LINE
70122
15



LINE
70123
15



LINE
70124
15



LINE
70105
17



LINE
70106
17



LINE
70107
17



LINE
70116
17



LINE
70117
17



LINE
70118
17



LINE
70127
17



LINE
70128
17



LINE
70129
17



SPOT
70103
19



SPOT
70104
19



SPOT
70114
19



SPOT
70115
19



SPOT
70125
19



SPOT
70126
19



SPOT
70108
21



SPOT
70119
21



SPOT
70130
21



PENDANT
70109
23



PENDANT
70120
23



PENDANT
70131
23



PENDANT
70110
25



PENDANT
70121
25



PENDANT
70132
25

RAIL INSTALLATION STEPS

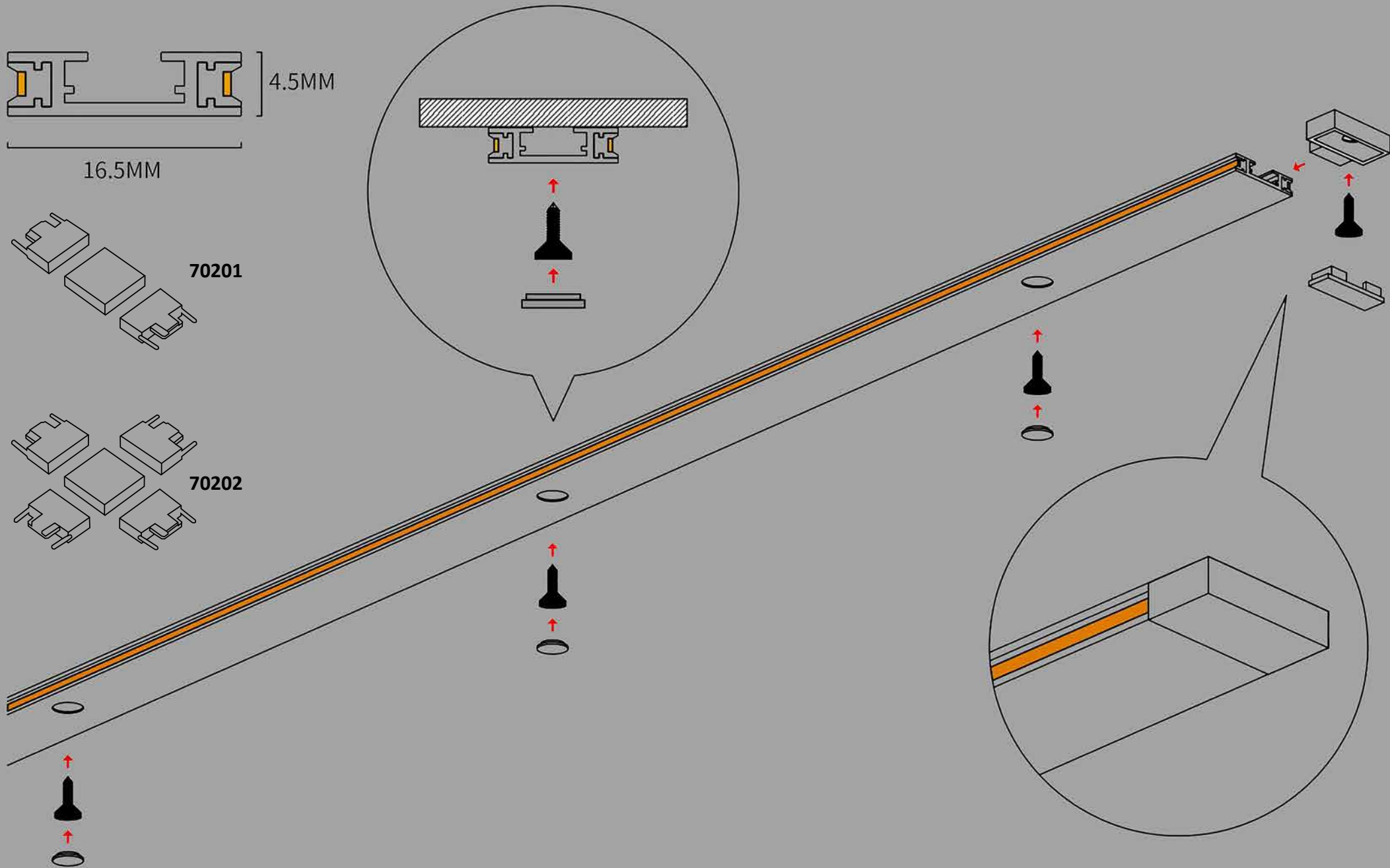

RAIL

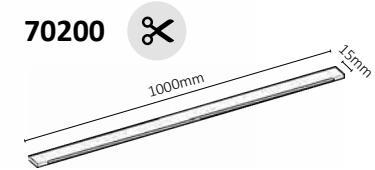
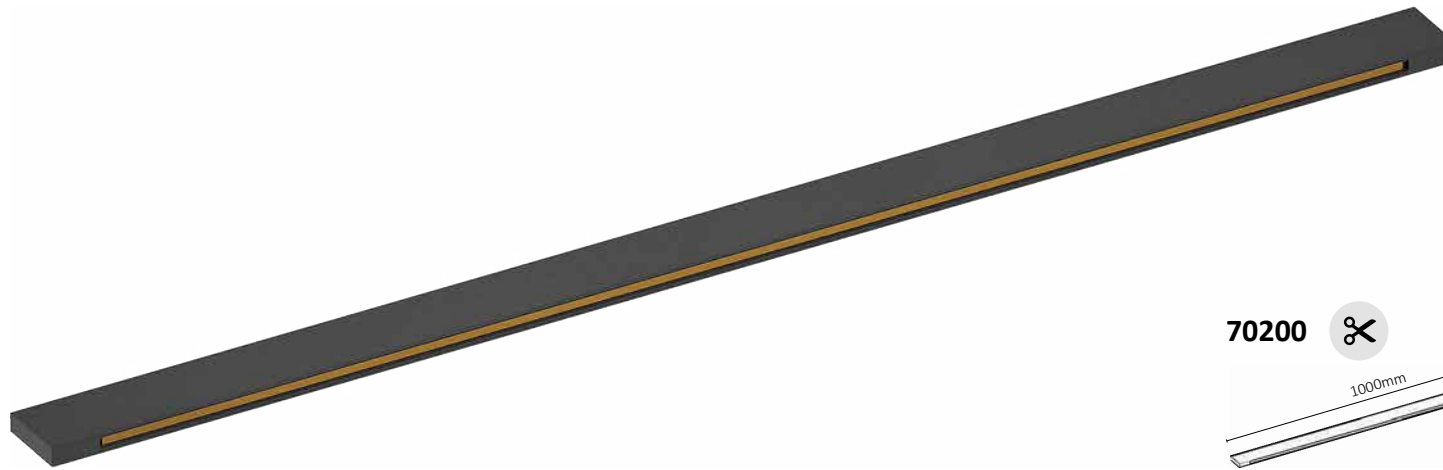

70199

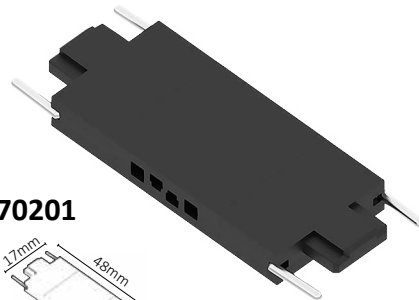
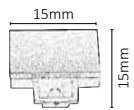

70201

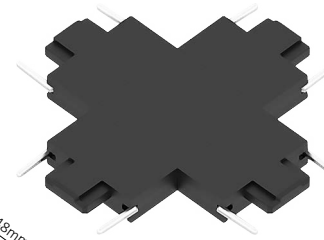
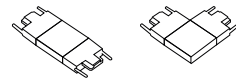
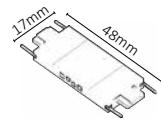

70202

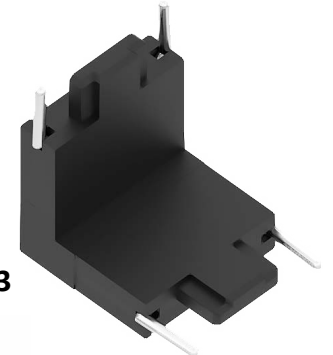
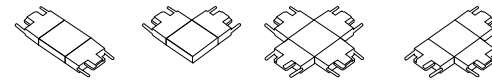
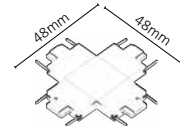

70203

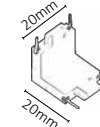

Information

metal/plastic

70199	IP20	black	5996595701994
70200	IP20	black	5996595702007
70201	IP20	black	5996595702014
70202	IP20	black	5996595702021
70203	IP20	black	5996595702038

BUILT-IN DRIVER



DRIVER

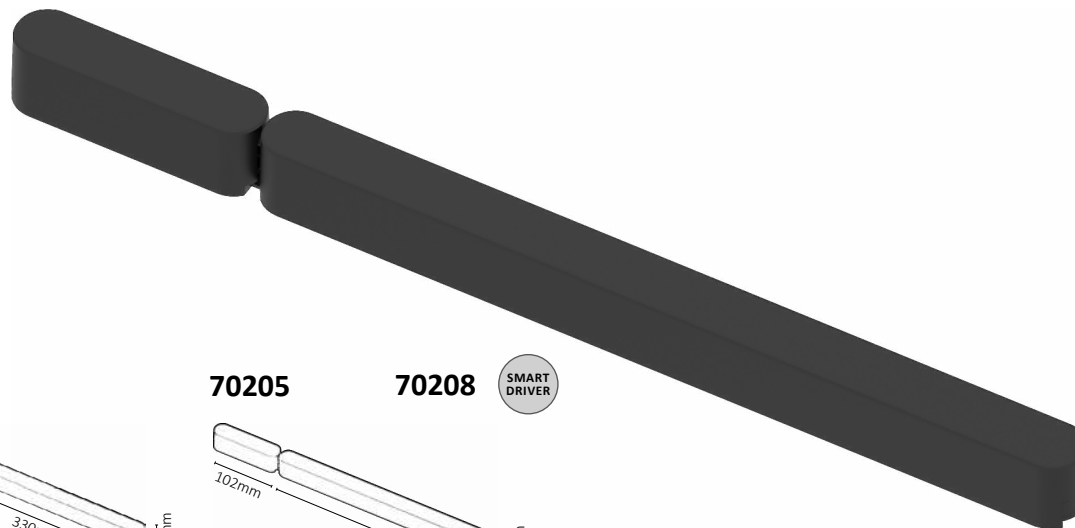

70204

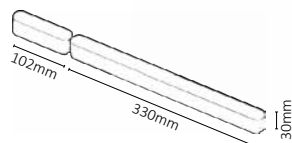

70205

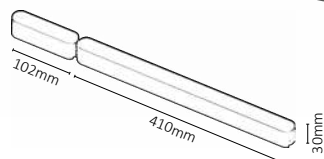

70208

SMART DRIVER



70206

BUILT-IN DRIVER
INPUT CABLE INCL.

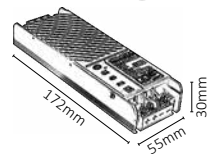

70207

BUILT-IN DRIVER
INPUT CABLE INCL.

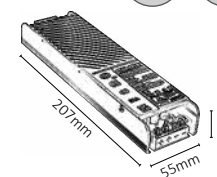

Information

metal/plastic

70204	AC 230V / DC 24V	80W	4.2A	IP20	black	5996595702045
70205	AC 230V / DC 24V	180W	4.2A	IP20	black	5996595702052
70206	AC 230V / DC 24V	100W	8.3A	IP20	black	5996595702069
70207	AC 230V / DC 24V	200W	4.2A	IP20	black	5996595702076
70208	AC 230V / DC 24V	100W	4.2A	IP20	black	5996595702083

CCT/SMART



5000K



4000K



3000K









70100



70111



70122

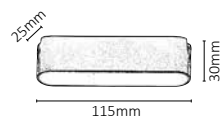

70101



70112



70123

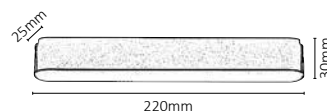

70102



70113



70124

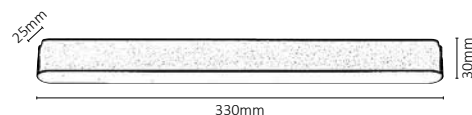

Information

metal/plastic

Model	Voltage	Power	Beam Angle	Beam Diameter	Color Temp.	IP Rating	Color	SKU
70100	24V	LED / 6W	300lm	630lm	3000K	IP20	black	5996595701000
70101	24V	LED / 12W	650lm	1270lm	3000K	IP20	black	5996595701017
70102	24V	LED / 16W	850lm	1730lm	3000K	IP20	black	5996595701024
70111	24V	LED / 6W	300lm	630lm	4000K	IP20	black	5996595701116
70112	24V	LED / 12W	650lm	1270lm	4000K	IP20	black	5996595701123
70113	24V	LED / 16W	850lm	1730lm	4000K	IP20	black	5996595701130
70122	24V	LED / 4W	160lm	530lm	2700K-5500K	IP20	black	5996595701222
70123	24V	LED / 7W	370lm	1250lm	2700K-5500K	IP20	black	5996595701239
70124	24V	LED / 13W	600lm	1860lm	2700K-5500K	IP20	black	5996595701246



rabalux LiTrack





70105



70116



70127

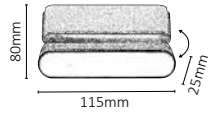

70106



70117



70128

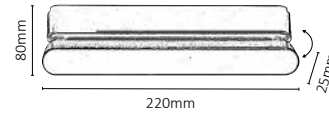

70107



70118



70129

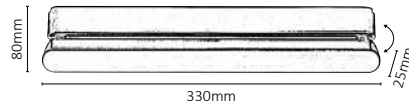





Information

metal/plastic





Model	Voltage	Power	Beam Spread	Beam Angle	Color Temp	IP Rating	Color	SKU
70105	24V	LED / 6W	300lm	630lm	3000K	IP20	black	5996595701055
70106	24V	LED / 12W	630lm	1270lm	3000K	IP20	black	5996595701062
70107	24V	LED / 16W	850lm	1730lm	3000K	IP20	black	5996595701079
70116	24V	LED / 6W	300lm	630lm	4000K	IP20	black	5996595701161
70117	24V	LED / 12W	630lm	1270lm	4000K	IP20	black	5996595701178
70118	24V	LED / 16W	850lm	1730lm	4000K	IP20	black	5996595701185
70127	24V	LED / 4W	180lm	530lm	2700K-5500K	IP20	black	5996595701277
70128	24V	LED / 7W	340lm	1250lm	2700K-5500K	IP20	black	5996595701284
70129	24V	LED / 13W	450lm	1860lm	2700K-5500K	IP20	black	5996595701291





- 70103 
- 70114 
- 70125   



- 70104 
- 70115 
- 70126   

Information

metal/plastic

70103	24V	LED / 6W	☼500lm	☼570lm	3000K	IP20	black	5996595701031
70104	24V	LED / 10W	☼800lm	☼880lm	3000K	IP20	black	5996595701048
70114	24V	LED / 6W	☼500lm	☼570lm	4000K	IP20	black	5996595701147
70115	24V	LED / 10W	☼800lm	☼880lm	4000K	IP20	black	5996595701154
70125	24V	LED / 5W	☼330lm	☼400lm	2700K-5500K	IP20	black	5996595701253
70126	24V	LED / 9W	☼660lm	☼1150lm	2700K-5500K	IP20	black	5996595701260







rabalux[®] LiTrack



SPOT



- 70108 
- 70119 
- 70130  

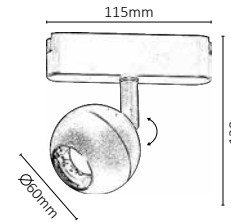

Information





metal/plastic

70108	24V	LED / 5W	⊞400lm	⊞440lm	3000K	IP20	black	5996595701086
70119	24V	LED / 5W	⊞400lm	⊞440lm	4000K	IP20	black	5996595701192
70130	24V	LED / 5W	⊞330lm	⊞400lm	2700K-5500K	IP20	black	5996595701307

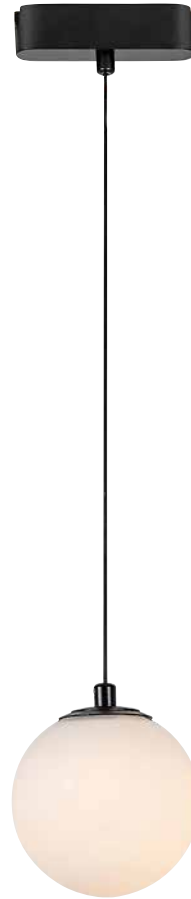

PENDANT



- 70109 
- 70120 
- 70131   

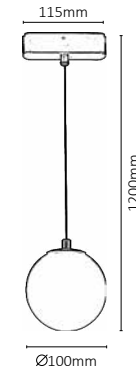

Information





metal/glass

70109	24V	LED / 5W	⊞400lm	⊞440lm	3000K	IP20	black	5996595701093
70120	24V	LED / 5W	⊞400lm	⊞440lm	4000K	IP20	black	5996595701208
70131	24V	LED / 5W	⊞360lm	⊞400lm	2700K-5500K	IP20	black	5996595701314



PENDANT



- 70110  WARM White
- 70121  NATURAL White
- 70132    SMART

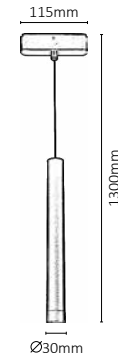

Information

metal/plastic

70110	24V	LED / 5W	220lm	350lm	3000K	IP20	black	5996595701109
70121	24V	LED / 5W	220lm	350lm	4000K	IP20	black	5996595701215
70132	24V	LED / 5W	200lm	400lm	2700K-5500K	IP20	black	5996595701321









EXAMPLE • PÉLDA • BEISPIEL

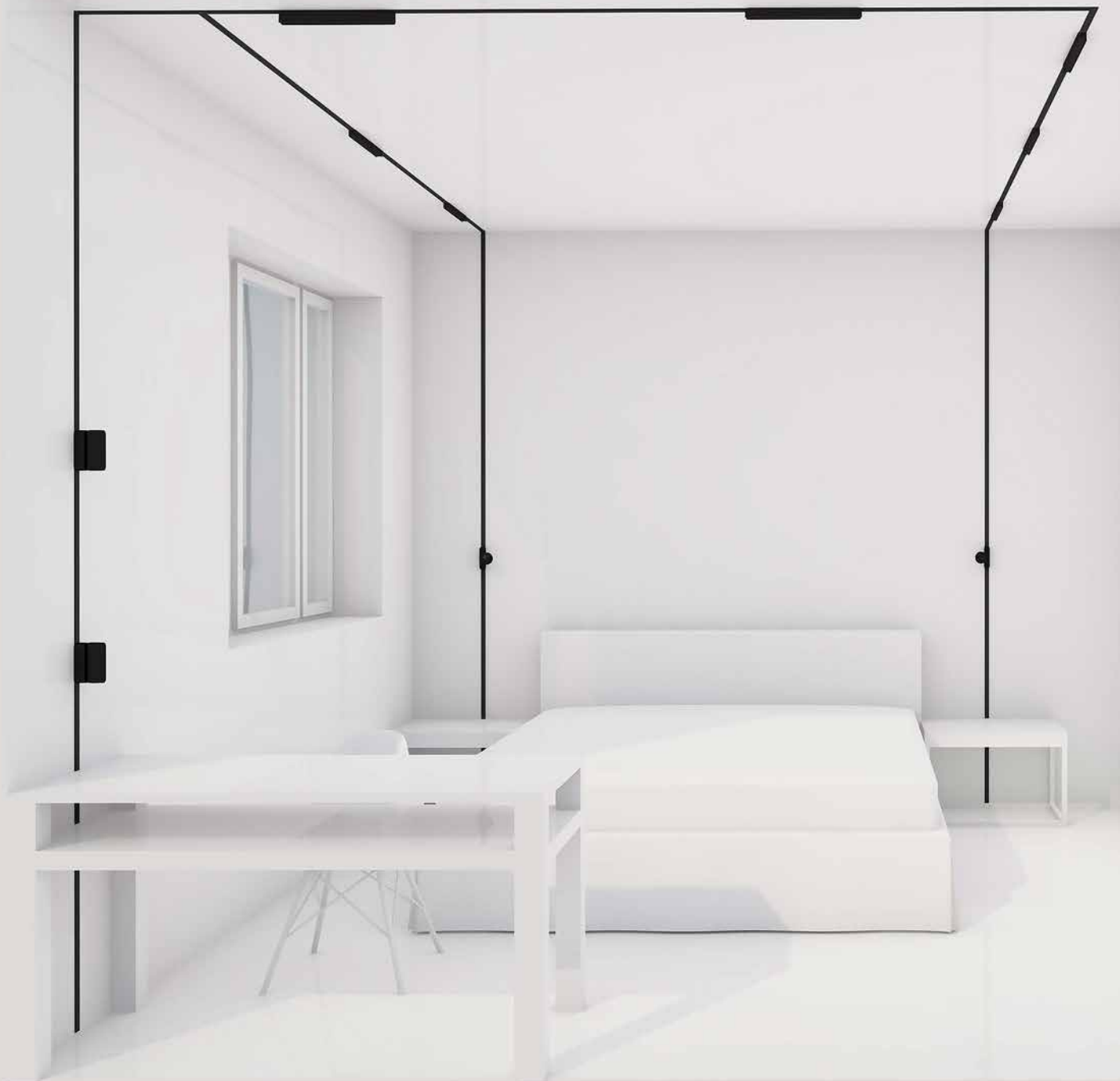

15m²

- 10 pcs LiTrack Rail (70200)
- 2 pcs LiTrack 33 cm Line (70102)
- 2 pcs LiTrack 11,5 cm Line (70100)
- 3 pcs LiTrack 22 cm Line (70101)
- 2 pcs LiTrack 22 cm Line (70106)
- 2 pcs LiTrack Spot (70108)
- 2 pcs X connecting (70202)
- 8 pcs straight connecting (70201)
- 1 pcs 100W built in driver (70206)

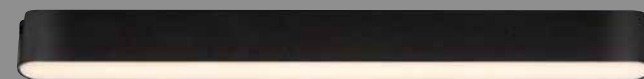

70102

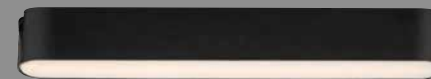

70101

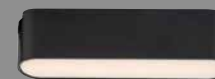

70100



70108



70106

40m²

- 14 pcs LiTrack Rail (70200)
- 4 pcs LiTrack 12 cm Line (70105)
- 1 pcs LiTrack 33 cm Line (70107)
- 2 pcs LiTrack 22 cm Line (70106)
- 3 pcs LiTrack Spot (70104)
- 3 pcs LiTrack Pendant (70109)
- 3 pcs X connecting (70202)
- 10 pcs straight connecting (70201)
- 1 pcs 200W built-in driver (70207)

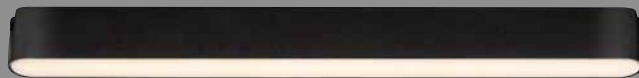

70105



70107



70104



70109



70109



KEY OF SYMBOLS • JELMAGYARÁZAT • ZEICHENERKLÄRUNG



GBR



HUN



GER



FRA



CZE



SVK



POL



UKR

	Symbols	Jelölések	Bezeichnungen	Symboles	Jména	Označenia	Oznaczenia	Позначення
	5 years guarantee	5 év garancia	5 Jahre Garantie	5 ans de garantie	záruka 5 let	Záruka 5 rokov	5-letnia gwarancja	гарантія 5 років
	built-in LED	beépített LED	LED inklusive	LED inclus	obsahuje LED	obsahuje LED diódy	Dioda LED w wyposażeniu	містить світлодіоди
	warm white light	meleg fehér fényű	warmweiß	blanc chaud	teplá bílá	teplá biela	ciepła biała	теплий білий
	natural white light	természetes fehér fényű	naturweiß	blanc naturel	přirozená bílá	přírodná biela	naturalna biała	натуральний білий
	dimmable	szabályozható fényerő	Lichtstärke Regler	Regleur d'intensité de la lumière	regulátor jasu	regulátor jasu	regulator natężenia światła	регулятор потужності світла
	Color temperature can be adjusted in 3 steps with a DIP switch	DIP kapcsolóval 3 lépésben szabályozható színhőmérséklet	Die Farbtemperatur kann mit einem DIP Schalter in 3 Stufen eingestellt werden	La température de couleur peut être ajustée en 3 étapes avec un interrupteur DIP	Teplotu barev lze nastavit pomocí DIP přepínače ve 3 krocích	Farebnú teplotu je možné nastaviť v 3 krokoch pomocou prepínača DIP	Temperaturę barwową można regulować w 3 krokach za pomocą przełącznika DIP	Колірну температуру можна регулювати в 3 кроки за допомогою DIP-перемикача
	Smart product	Okos termék	intelligentes Produkt	produit intelligent	chytrý produkt	inteligentný produkt	inteligentny produkt	розумний продукт
	low voltage	kisfeszültségű	Niederspannung	Basse tension	Nízké napětí	Nízke napätie	Niskie napięcie	Низька напруга
	smart driver	okos vezérlőegység	intelligenter Treiber	pilote intelligent	chytrý ovladač	inteligentný ovládač	inteligentny sterownik	розумний драйвер
	input cable included	bementi kábelt tartalmaz	Eingangskabel enthalten	Câble d'entrée inclus	Vstupní kabel je součástí balení	Vstupný kábel je súčasťou balenia	Kabel wejściowy w zestawie	Вхідний кабель включений
	Bult in driver	beépített vezérlőegység	integrierter Treiber	pilote intégré	vestavěný ovladač	vstavany ovládač	wbudowany sterownik	вбудований драйвер
	suitable for cutting	vágható	zerschneidbar	peut être coupé	lze stříhat	možno strihať	cięcie jest możliwe	можна різати

KEY OF SYMBOLS • JELMAGYARÁZAT • ZEICHENERKLÄRUNG



	Simboluri	Označavanje	Oznake	Oznake	Символи	Simboliai	Simboli	Sümbolid
	5 ani garanție	5 godina garancije	5 godina jamstva	5 let garancije	5 години гаранция	5 metų garantija	5 gadu garantija	5-aastane garantii
	LED încorporat	ugrađeni LED	ugrađeni LED	vgrajen LED	вграден LED	įmontuotas LED įrenginys	ieibūvēta LED	sisseehitatud LED
	alb cald	toplo bela	toplo bijelo	toplo bela	топло бяло	šiltai balta	silti balts	soe valge
	alb natural	prirodno bela	prirodno bijelo	naravno bela	естественно бяло	natūraliai balta	dabīgi balts	loomulik valge
	regulator intensitate lumina	regulator svetlosti	regulator jačie svjetla	zatemnilnik	с регулатор за силата на светлина	pritemdymo įtaisas	gaismmainis	hāvardi
	Temperatura de culoare poate fi reglată în 3 trepte cu un comutator DIP	Temperatura boje se može podesiti u 3 koraka pomoću DIP prekidača	Temperatura boje može se podesiti u 3 koraka pomoću DIP prekidača	Barvno temperaturo lahko nastavite v 3 korakih s DIP stikalom	Цветовата температура може да се регулира на 3 стъпки с DIP превключвател	Spalvos temperatūrą galima reguliuoti 3 žingsniais DIP jungikliu	Krāsu temperatūru var regulēt 3 soļos ar DIP slēdzi	Värvitemperatuuri saab DIP-lülitiga reguleerida 3 astmes
	produs inteligent	Pametnan proizvod	pametnan proizvod	pameten izdelek	интелигентен продукт	protingas produktas	gudrs produkts	tark toode
	Tensiune joasă	Nizak napon	Niski napon	Nizka napetost	Ниско напрежение	žema įtampa	Zems spriegums	Madalpinge
	driver inteligent	pametni upravljač	pametni upravljač	pametni gonilnik	интелигентен драйвер	išmanusis vairuotojas	gudrs vadītājs	tark draiver
	Cablu de intrare inclus	Uključen ulazni kabl	Uključen ulazni kabel	Vhodni kabel je priložen	Включен входен кабел	Įtrauktas įvesties kabelis	Iekļauts ievades kabelis	Sisendkaabel on kaasas
	driver integrat	ugrađeni drajver	ugrađeni upravljački program	vgrajen gonilnik	вграден драйвер	integruotas tvarkyklė	ieibūvēts draiveris	sisseehitatud draiver
	poate fi tăiat	može se seći	može se rezati	mogoče rezati	може да се реже	tinka pjaustymui	piemērots griešanai	sobi lõikamiseks

CONTENTS • TARTALOMJEGYZÉK • INHALTSVERZEICHNIS

Art. number	Name	Page
Cikkszám	Név	Oldal
Art. nummer	Name	Seite

70100	Line	15
70101	Line	15
70102	Line	15
70103	Spot	19
70104	Spot	19
70105	Line	17
70106	Line	17
70107	Line	17
70108	Spot	21
70109	Pendant	23

Art. number	Name	Page
Cikkszám	Név	Oldal
Art. nummer	Name	Seite

70110	Pendant	25
70111	Line	15
70112	Line	15
70113	Line	15
70114	Spot	19
70115	Spot	19
70116	Line	17
70117	Line	17
70118	Line	17
70119	Spot	21

Art. number	Name	Page
Cikkszám	Név	Oldal
Art. nummer	Name	Seite

70120	Pendant	23
70121	Pendant	25
70122	Line	15
70123	Line	15
70124	Line	15
70125	Spot	19
70126	Spot	19
70127	Line	17
70128	Line	17
70129	Line	17

Art. number	Name	Page
Cikkszám	Név	Oldal
Art. nummer	Name	Seite

70130	Spot	21
70131	Pendant	23
70132	Pendant	25
70199	Rail	9
70200	Rail	9
70201	Rail	9
70202	Rail	9
70203	Rail	9
70204	Driver	11
70205	Driver	11

Art. number	Name	Page
Cikkszám	Név	Oldal
Art. nummer	Name	Seite

70206	Driver	11
70207	Driver	11
70208	Driver	11

IMPRINT • IMPRESSZUM • IMPRESSUM

English

Colour and pattern discrepancy are possible. We are entitled to change the pattern.
We don't bear the responsibility of the printing failure.

Magyar

Szín és minta eltérés lehetséges. A minta változtatás jogát fenntartjuk!
Az esetleges nyomdai hibákért elnézésüket kérjük és azokért felelősséget nem vállalunk.

Deutsch

Farbe und Musterunterschied ist möglich. Wir halten das Recht von Musteränderung aufrecht.
Vor die eventuellen Druckfehler bitten wir um Entschuldigung und vor die Fehler können wir die Verantwortung nicht übernehmen.

Grafikai munkák: Visionext Reklámstúdió
Nyomdai munkák: Keskeny és Társai 2001 Kft.

CONTACT • ELÉRHETŐSÉGEINK • KONTAKT

CENTRE/KÖZPONT/ZENTRALE



Magyarország/Hungary

RÁBALUX HEAD OFFICE
RÁBALUX VILÁGÍTÁSTECHNIKA ZRT.
VILÁGÍTÁSTECHNIKA GYÁRTÁS ÉS FORGALMAZÁS/
LIGHTING PRODUCTION AND DISTRIBUTION

9027 Győr, Körtefa u. 5.
Tel.: +36 96 526 716
E-mail: info@rabalux.com
www.rabalux.com

AFFILIATES/LEÁNYVÁLLALATOK/ZWEIGSTELLEN



Bulgaria

РАБАЛУКС ЕООД / RABALUX EOOD
ул. "Андрей Николов" №15,
1111 София,
България
Тел/Факс: +359 2 936 00 97
E-mail: infobg@rabalux.com
www.rabalux.bg



Croatia, Bosnia Herzegovina, Montenegro



RABALUX RASVJETA d.o.o.
Ulica grada Gospića 1a
10000 Zagreb
Tel.: +385 1 652 80 66
E-mail: infocro@rabalux.com
www.rabalux.hr



Czech Republic

RABALUX CZ Světidla s.r.o.
Kaštanová 141/a, 617 00 Brno,
Česká Republika
Tel.: +420 739 665 322
E-mail: infocz@rabalux.com
www.rabalux.cz



Hungary

Rábalux Magyarország Kft.
Magyarország
9027 Győr,
Körtefa u. 5.
Tel.: +36 96 526 716
E-mail: infohu@rabalux.com
www.rabalux.hu



Lithuania, Latvia, Estonia



UAB „Rabalux Baltic“
Bičiulių g. 29,
LT-14182 Bukiškis,
Vilniaus r. Lietuva
Tel.: +370 6161 3066
E-mail: infobaltic@rabalux.com
www.rabalux.lt



Poland

Rabalux Sp. z o.o.
ul. Sołtysia 119, 40-750 Katowice,
Polska
Tel.: +48 32 254 61 34
E-mail: infopl@rabalux.com
zamowienia@rabalux.com
www.rabalux.pl



Romania

SC RABALUX SRL
Cluj-Napoca, str. Fabricii,
nr. 93-103, jud. CLUJ
Romania
cod postal: 400632
Tel.: +40 264 456 040
E-mail: infofo@rabalux.com
www.rabalux.ro



Serbia, Northern Macedonia



Rabalux SRB d.o.o.
Autoput br.20
11080 Beograd –
Zemun, Srbija
Mob: + 381 60 444 3977;
Tel.: +381(0)11 2013 986
E-mail: infosrb@rabalux.com
www.rabalux.rs



Slovakia

RABALUX SK. Svetidlá, s.r.o.
Alžbetínske nám. 328,
929 01 Dunajská Streda,
Slovenská Republika
Tel.: +421 31 551 54 04
E-mail: infosk@rabalux.com
www.rabalux.sk



Ukraine

ТОВ Рабалукс,
вул. Рилеева 4, м. Ужгород,
Україна, 88017
тел.: +38 0312 64 04 00,
моб.тел.: +38 067 310 05 20
E-mail: infooua@rabalux.com
www.rabalux.ua

OFFICIAL RESELLERS/MEGBÍZOTT VISZONTELADÓK/BEAUFTRAGTE WIEDERVERKÄUFER



Germany

Sinnocon GmbH
01156 Dresden,
Breitscheidstr. 45
Tel.: +49 351 65335641
E-mail: rabalux@sinnocon.de
www.sinnocon.de



Slovenia

Lagea d.o.o.
Brezina 19c
8250 Brežice
Republika Slovenija
Tel.: +386 70 292 70 20
E-mail: elmat@lagea.si



Greece

ANASTASIADI SA
1km Katerini-Ganohora Road,
Katerini, 60100
Tel.: +30 2351039757
E-mail: eshop@anastasiadi.gr
www.anastasiadi.gr



Greece

S.MELISSOURGOS CO OE
8 Kourtiou St,
11146 Galatsi,
Tel.: +0030 2102136040
E-mail: info@melissourgos.com.gr
melissourgos.com.gr



Portugal

STORM LIGHT,LDA
Rua António Pereira Vidal Xavier nº,
3750-802 Valongo do Vouga,
Tel.: 234 661 068
E-mail: geral@storm-light.pt
www.storm-light.pt



Spain

Buyled Led Lighting S.L
03007, Alicante,
ES, C/Gillen de Castro 1
Tel.: +34 654 870 866
E-mail: info@buyled.es
www.buyled.es



Italy

Fra.Co.Distribuzione Srl
Sp1 km24,
90047 Partinico (PA)
Tel.: 0039 0915071547
E-mail: info@fracodistribuzione.it
www.fracodistribuzione.it



Finland

Focus Interiors Oy
Kuusipolku 35,
37150 Nokia
Tel.: +358 (0)10 3270 520
E-mail: info@focusinteriors.fi
www.focusinteriors.fi



Albania

FAAM Light sh.p.k.
Rruga Muhedin Llagani,
Kompleksi Square 21,
Tirana, Albania
Tel.: +355 67 446 6888
E-mail: info@faamlight.al
www.faaamlight.al



Qatar

GO GREEN INTERNATIONAL
TRADING W.L.L
New Salata, C Ring Road,
Sharq Capital Building-311 P.O Box 37372,
Doha, Qatar
Tel.: (+974) 4409 5443, (+974) 5552 9088
E-mail: sales@ggilighting.com
www.ggilighting.com



United Kingdom

Lighting Direct
24-26 Vincent Ave,
Crownhill, Milton Keynes
Buckinghamshire, MK8 0AB
E-mail: customerservice@lighting-direct.co.uk
www.lighting-direct.co.uk



LITrack System Info

www.rabalux.com